

Power Relay G7J

A High-capacity, High-dielectric-strength, Multi-pole Relay Used Like a Contactor

- Miniature hinge for maximum switching power for motor loads as well as resistive and inductive loads.
- No contact chattering for momentary voltage drops up to 50% of rated voltage.
- Withstanding more than 4 kV between contacts that are different in polarity and between the coil and contacts.
- Flame-resistant materials (UL94V-0-qualifying) used for all insulation material.
- Standard models approved by UL and CSA.

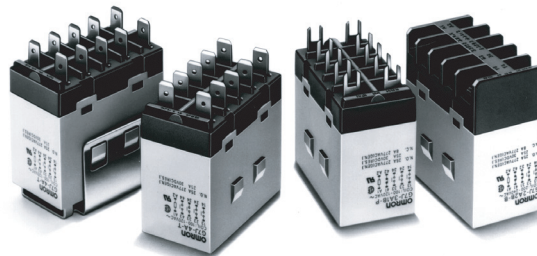

Model Number Structure

Model Number Legend

G7J - - -
 1 2 3

1. Contact Form

- 4A: 4PST-NO
- 3A1B: 3PST-NO/SPST-NC
- 2A2B: DPST-NO/DPST-NC

2. Terminal Shape

- P: PCB terminals
- B: Screw terminals
- T: Quick-connect terminals (#250 terminal)



3. Contact Structure

- Z: Bifurcated contact
- None: Single contact

Note: For bifurcated contact type, output is 1NO (4PST-NO) or 1NC (3PST-NO/SPST-NC).

Ordering Information

List of Models

Mounting type	Contact form	PCB terminals	Screw terminals	Quick-connect terminals
				
PCB mounting	4PST-NO	G7J-4A-P, G7J-4A-PZ	---	---
	3PST-NO/SPST-NC	G7J-3A1B-P, G7J-3A1B-PZ	---	---
	DPST-NO/DPST-NC	G7J-2A2B-P	---	---
W-bracket (see note)	4PST-NO	---	G7J-4A-B, G7J-4A-BZ	G7J-4A-T, G7J-4A-TZ
	3PST-NO/SPST-NC	---	G7J-3A1B-B, G7J-3A1B-BZ	G7J-3A1B-T, G7J-3A1B-TZ
	DPST-NO/DPST-NC	---	G7J-2A2B-B	G7J-2A2B-T

Note: These Relays need a W-bracket (sold separately) for mounting. When ordering specify the voltage.
 Example: G7J-4A-P 240 VAC
 Rated coil voltage

PCB Terminals

Contact form	Rated voltage (V)	Model
4PST-NO	24, 50, 100 to 120, 200 to 240 VAC	G7J-4A-P
	12, 24, 48, 100 VDC	
3PST-NO/ SPST-NC	24, 50, 100 to 120, 200 to 240 VAC	G7J-3A1B-P
	12, 24, 48, 100 VDC	
DPST-NO/DPST- NC	24, 50, 100 to 120, 200 to 240 VAC	G7J-2A2B-P
	12, 24, 48, 100 VDC	

PCB Terminals (Bifurcated Contact)

Contact form	Rated voltage (V)	Model
4PST-NO	200 to 240 VAC 24 VDC	G7J-4A-PZ
3PST-NO/ SPST-NC	12, 24 VDC	G7J-3A1B-PZ

W-bracket Screw Terminals

Contact form	Rated voltage (V)	Model
4PST-NO	24, 50, 100 to 120, 200 to 240 VAC	G7J-4A-B
	12, 24, 48, 100 VDC	
3PST-NO/ SPST-NC	24, 50, 100 to 120, 200 to 240 VAC	G7J-3A1B-B
	12, 24, 48, 100 VDC	
DPST-NO/ DPST-NC	24, 50, 100 to 120, 200 to 240 VAC	G7J-2A2B-B
	12, 24, 48, 100 VDC	

■ Accessories (Order Separately)

Name	Model	Applicable Relay
W-bracket	R99-04 for G5F	G7J-4A-B G7J-3A1B-B G7J-2A2B-B G7J-4A-T G7J-3A1B-T G7J-2A2B-T

Application Examples

- Compressors for air conditioners and heater switching controllers.
- Switching controllers for power tools or motors.
- Lamp controls, motor drivers, and power supply switching controllers in copy machines, facsimile machines, and other office equipment.
- Power controllers for packers or food processing equipment.
- Power controllers for inverters.

Screw Terminals (Bifurcated Contact)

Contact form	Rated voltage (V)	Model
3PST-NO/ SPST-NC	200 to 240 VAC	G7J-3A1B-BZ
	6, 12, 24, 48, 100 VDC	

Tab Terminals

Contact form	Rated voltage (V)	Model
4PST-NO	24, 50, 100 to 120, 200 to 240 VAC	G7J-4A-T
	12, 24, 48, 100 VDC	
3PST-NO/ SPST-NC	24, 50, 100 to 120, 200 to 240 VAC	G7J-3A1B-T
	12, 24, 48, 100 VDC	
DPST-NO/ DPST-NC	24, 50, 100 to 120, 200 to 240 VAC	G7J-2A2B-T
	12, 24, 48, 100 VDC	

Tab Terminals (Bifurcated Contact)

Contact form	Rated voltage (V)	Model
4PST-NO	200 to 240 VAC	G7J-4A-TZ

Consult your OMRON representative for details on models not mentioned in this document.

Specifications

■ Coil Ratings

Rated voltage		Rated current	Coil resistance	Must-operate voltage	Must-release voltage	Max. voltage	Power consumption
AC	24 VAC	75 mA	---	75% max. of rated voltage	15% min. of rated voltage	110% of rated voltage	Approx. 1.8 to 2.6 VA
	50 VAC	36 mA	---				
	100 to 120 VAC	18 to 21.6 mA	---				
	200 to 240 VAC	9 to 10.8 mA	---				
DC	6 VDC	333 mA	18 Ω		10% min. of rated voltage		Approx. 2.0 W
	12 VDC	167 mA	72 Ω				
	24 VDC	83 mA	288 Ω				
	48 VDC	42 mA	1,150 Ω				
	100 VDC	20 mA	5,000 Ω				

- Note:** 1. The rated current and coil resistance are measured at a coil temperature of 23°C with tolerances of +15%/–20% for AC rated current and ±15% for DC coil resistance. (The values given for AC rated current apply at 50 Hz or 60 Hz.)
 2. Performance characteristic data are measured at a coil temperature of 23°C.
 3. The maximum voltage is one that is applicable to the Relay coil at 23°C.

■ Contact Ratings

Item	Resistive load (cos φ = 1)	Inductive load (cos φ = 0.4)	Resistive load
Contact mechanism	Double break		
Contact material	Ag alloy		
Rated load	NO: 25 A at 220 VAC (24 A at 230 VAC) NC: 8 A at 220 VAC (7.5 A at 230 VAC)		NO: 25 A at 30 VDC NC: 8 A at 30 VDC
Rated carry current	NO: 25 A (1 A) NC: 8 A (1 A)		
Max. switching voltage	250 VAC		125 VDC
Max. switching current	NO: 25 A (1 A) NC: 8 A (1 A)		

Note: The values in parentheses indicate values for a bifurcated contact.

■ Characteristics

Contact resistance (see note 2)	50 mΩ max.
Operate time (see note 3)	50 ms max.
Release time (see note 3)	50 ms max.
Max. operating frequency	Mechanical: 1,800 operations/hr Electrical: 1,800 operations/hr
Insulation resistance (see note 4)	1,000 MΩ min. (at 500 VDC)
Dielectric strength	4,000 VAC, 50/60 Hz for 1 min between coil and contacts 4,000 VAC, 50/60 Hz for 1 min between contacts of different polarity 2,000 VAC, 50/60 Hz for 1 min between contacts of same polarity
Impulse withstand voltage	10,000 V between coil and contact (with 1.2 x 50 μs impulse wave)
Vibration resistance	Destruction: 10 to 55 to 10 Hz, 0.75-mm single amplitude (1.5-mm double amplitude) Malfunction: NO:10 to 55 to 10 Hz, 0.75-mm single amplitude (1.5-mm double amplitude) NC:10 to 26 to 10 Hz, 0.75-mm single amplitude (1.5-mm double amplitude)
Shock resistance	Destruction: 1,000 m/s ² Malfunction: NO:100 m/s ² NC:20 m/s ²
Endurance	Mechanical: 1,000,000 operations min. (at 1,800 operations/hr) Electrical: 100,000 operations min. (at 1,800 operations/hr) (see note 5)
Error rate (see note 6)	100 mA at 24 VDC (bifurcated contact: 24 VDC 10 mA)
Ambient temperature	Operating: –25°C to 60°C (with no icing or condensation)
Ambient humidity	Operating: 5% to 85%
Weight	PCB terminal: approx. 140 g Screw terminal: approx. 165 g Quick-connect terminal: approx. 140 g

- Note:**
1. The above values are all initial values.
 2. The contact resistance was measured with 1 A at 5 VDC using the voltage drop method.
 3. The operate and the release times were measured with the rated voltage imposed with any contact bounce ignored at an ambient temperature of 23°C.
 4. The insulation resistance was measured with a 500-VDC megger applied to the same places as those used for checking the dielectric strength.
 5. The electrical endurance was measured at an ambient temperature of 23°C.
 6. This value was measured at a switching frequency of 60 operations per minute.

■ Approved Standards

The G7J satisfies the following international standards. Approval for some international markings and symbols are still pending, however, and information on them will be added when they are approved.

UL (File No. E41643)

CSA (File No. LR35535)

Coil ratings	Contact ratings		Number of test operations
24 to 265 VAC 6 to 110 VDC	NO contact	25 A 277 VAC, Resistive	30,000
		25 A 120 VAC, General Use	
		25 A 277 VAC, General Use	
		25 A 240 VAC, General Use	
		1.5 kW 120 VAC, Tungsten	100,000
		1.5 hp 120 VAC	
		3 hp 240/265/277 VAC	
		3-phase 3 hp 240/265/277 VAC	6,000
		3-phase 5 hp 240/265/277 VAC	
		20FLA/120LRA 120 VAC	
		17FLA/102LRA 277 VAC	
		TV-10 120 VAC	30,000
		25 A 30 VDC, Resistive	
		*1 A 277 VAC, General Use	
	NC contact	8 A 277 VAC, Resistive	30,000
		8 A 120 VAC, General Use	
		8 A 277 VAC, General Use	
		8 A 30 VDC, Resistive	
		*1 A 277 VAC, General Use	
		*1 A 277 VAC, General Use	

Note: *These ratings are bifurcated contact ratings.

Reference

UL approval: UL508 for industrial control devices
UL1950 for information processing equipment including business machines

CSA approval: CSA C22.2 No. 14 for industrial control devices
CSA C22.2 No. 950 for information processing equipment including business machines

VDE (File No. 5381UG)

Model	Coil ratings	Contact ratings	
		NO contact	NC contact
G7J-4A-B(P) (T) (Z)	6, 12, 24, 48, 100 VDC	25 A 240 VAC $\cos\phi = 0.4$	8 A 240 VAC $\cos\phi = 0.4$
G7J-2A2B(P) (T)	24, 50, 100 to 120, 200 to 240 VAC	25 A 240 VAC $\cos\phi = 1$	8 A 240 VAC $\cos\phi = 1$
G7J-3A1B-B(P) (T) (Z)		25 A 30 VDC $L/R \geq 1$	8 A 30 VDC $L/R \geq 1$
		*1 A 240 VAC $\cos\phi = 0.4$	*1 A 240 VAC $\cos\phi = 0.4$

Note: Add the suffix "-KM" to the model number when ordering.

*These ratings are bifurcated contact ratings.

Reference

VDE approval: EN60255-1-00: 1997
EN60255-23: 1996

KEMA (File No. 2001291.02)

Model	Coil ratings	Contact ratings
		NO contact
G7J-4A-B(P) (T) (Z) G7J-2A2B(P) (T)	200 to 240 VAC	Class AC1: 25 A at 220 VAC 11.5 A at 380 to 480 VAC
G7J-3A1B-B(P) (T) (Z)	6, 12, 24, 48, 100 VDC 24, 50, 100 to 120, 200 to 240 VAC	Class AC3: 11.5 A at 220 VAC and 8.5 A at 380 to 480 VAC *Class AC1: 1 A at 220 VAC

Note: Add the suffix “-KM” to the model number when ordering.

*This rating is the bifurcated contact rating.

Reference

KEMA approval: EN60947-4-1 for contacts
IEC947-4-1 for contacts

Engineering Data

Maximum Switching Power

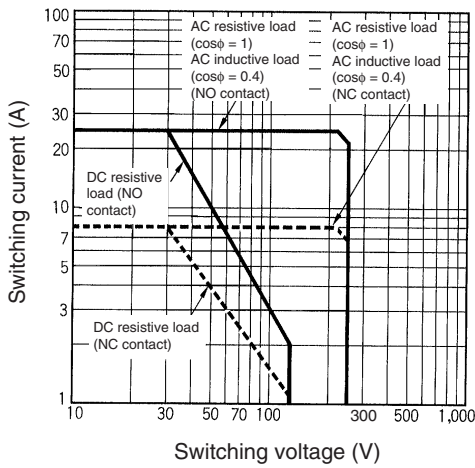

Endurance

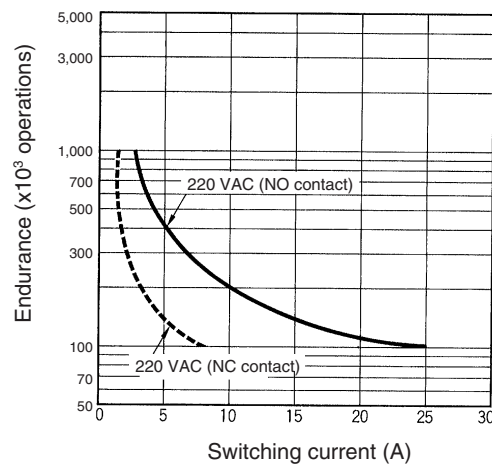

Malfunctioning Shock

G7J-2A2B

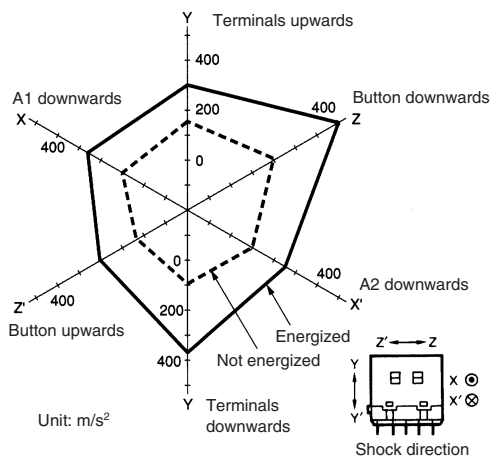

Number of samples: 5

Measurement conditions: Increase and decrease the specified shock gradually imposed in ±X, ±Y, and ±Z directions three times each with the Relay energized and not energized to check the shock values that cause the Relay to malfunction.

Criteria: There must not be any contact separation for 1 ms or greater with a shock of 100 m/s² imposed when the coil is energized or with a shock of 20 m/s² when the coil is not energized.

■ Ambient Temperature vs. Must-operate and Must-release Voltage

G7J 100 to 120 VAC

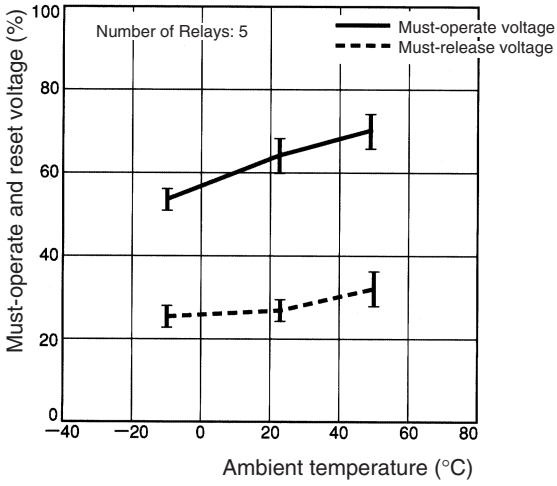

■ Ambient Temperature vs. Coil Temperature Rise

G7J-4A 100 to 120 VAC

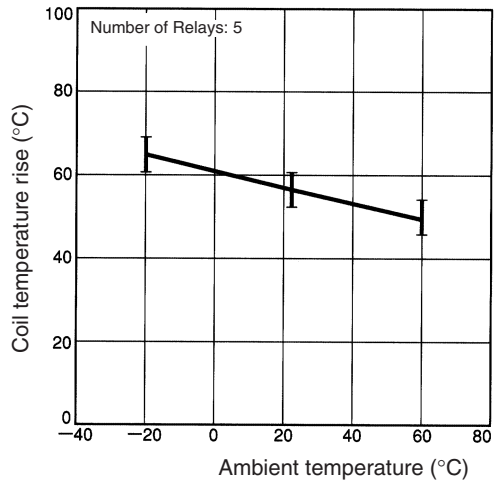

G7J 24 VDC

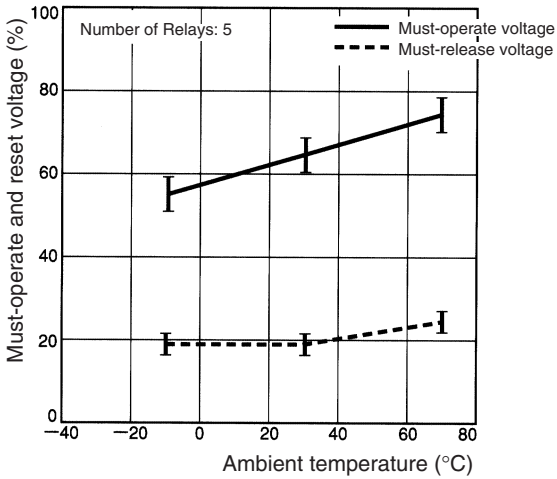

G7J-4A 24 VDC

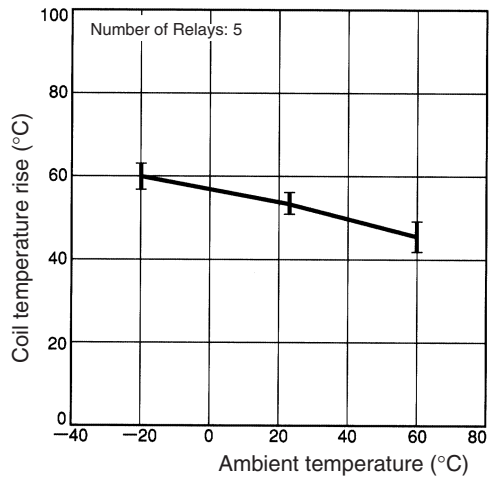

Motor Load

Item	G7J-4A-P, G7J-3A1B-P, G7J-4A-B, G7J-3A1B-B, G7J-4A-T, G7J-3A1B-T
Load	3φ, 220 VAC, 2.7 kW (with a inrush current of 78 A and a breaking current of 13 A)
Endurance	Electrical: 100,000 operations min.

Dimensions

Note: All units are in millimeters unless otherwise indicated.

Screw Terminals with W-bracket

G7J-4A-B, G7J-4A-BZ, G7J-3A1B-B, G7J-3A1B-BZ, G7J-2A2B-B

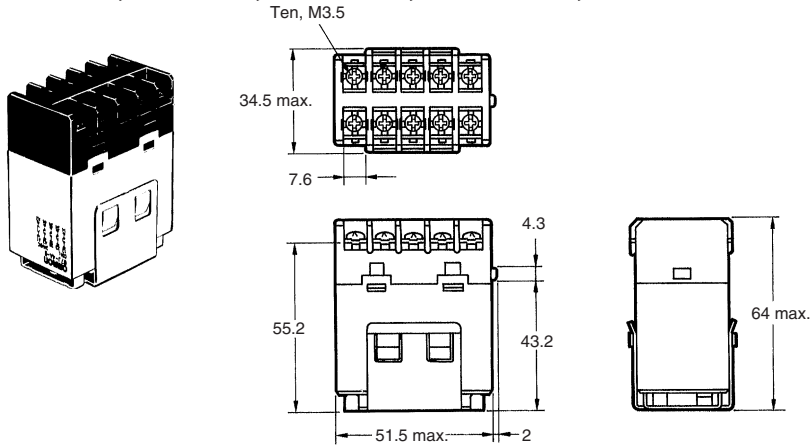

Mounting Holes

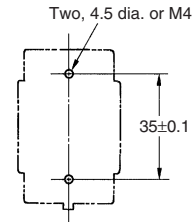

Quick-connect Terminals with W-bracket

G7J-4A-T, G7J-4A-TZ, G7J-3A1B-T, G7J-3A1B-TZ, G7J-2A2B-T

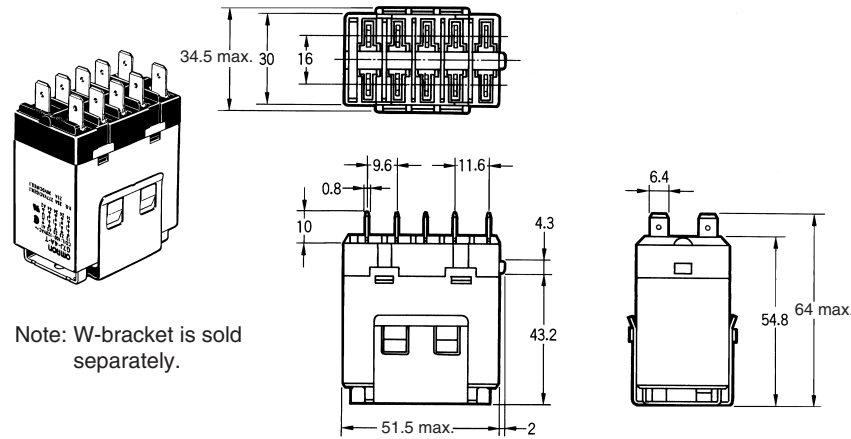

Mounting Holes

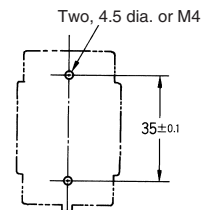

Note: W-bracket is sold separately.

PCB Terminals with PCB Mounting

G7J-4A-P, G7J-4A-PZ, G7J-3A1B-P, G7J-3A1B-PZ, G7J-2A2B-P

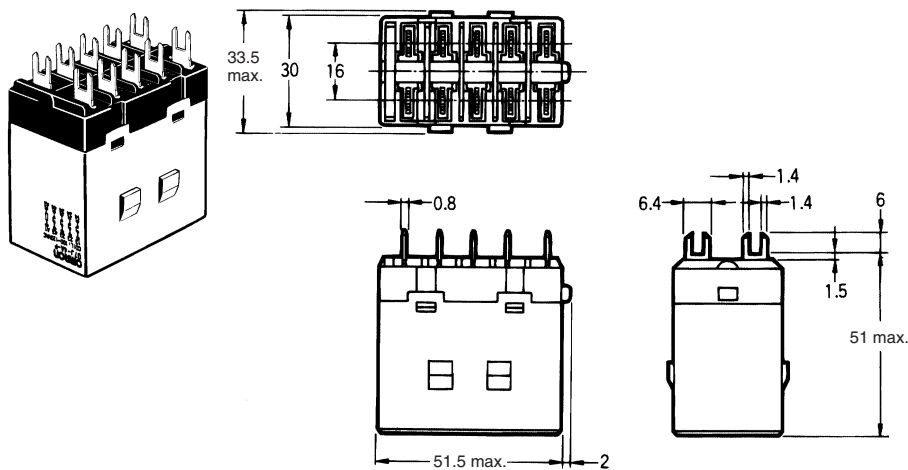

Mounting Dimensions

Terminal Arrangement/Internal Connections

G7J-4A-P(B) (T) (Z)

G7J-3A1B-P(B) (T) (Z)

G7J-2A2B-P(B) (T)

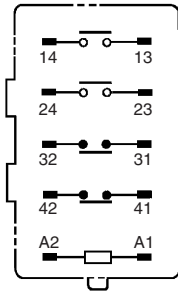
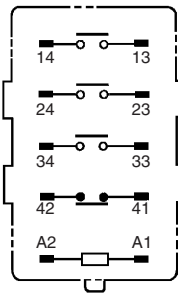
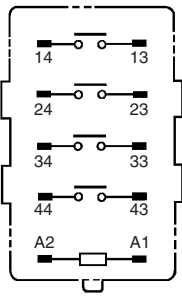

Note: Terminals 43 and 44 of the G7J-4A-P(B)(T)(Z) and contacts 41 and 42 of the G7J-3A1B-P(B)(T)(Z) are bifurcated contacts.

The coil has no polarity.

Accessories (Order Separately)

R99-04 W-bracket (for G5F)

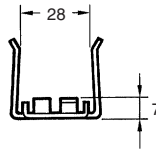
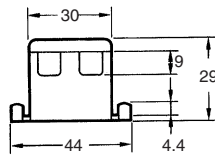
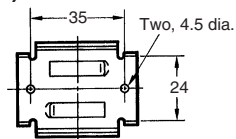
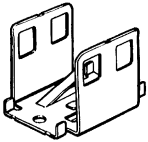

Mounting Holes

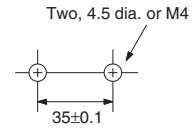

Precautions

■ Correct Use

Installation

PCB Terminal-equipped Relays weigh approximately 140 g. Be sure that the PCB is strong enough to support them. We recommend dual-side through-hole PCBs to reduce solder cracking from heat stress.

Mount the G7J with its test button facing downwards. The Relay may malfunction due to shock if the test button faces upwards. Be careful not to press the test button by mistake because the contacts will go ON if the test button is pressed.

Be sure to use the test button for test purposes only. The test button is used for Relay circuit tests, such as a circuit continuity test. Do not attempt to switch the load with the test button.

Micro Loads

The G7J is used for switching power loads, such as motor, transformer, solenoid, lamp, and heater loads. Do not use the G7J for switching minute loads, such as signals. Use a Relay with a bifurcated contact construction for switching micro loads, in which case, however, only SPST-NO or SPST-NC output is obtained.

Soldering PCB Terminals

Be sure to solder the PCB terminals manually only. In the case of automatic soldering, some flux may stick to the test button and the G7J. As a result, the G7J may malfunction.

The G7J is not of enclosed construction. Therefore, do not wash the G7J with water or any detergent.

Connecting

Refer to the following diagram when connecting a wire with a screw terminal to the G7J.

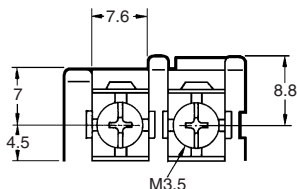

Allow suitable slack on leads when wiring, and do not subject the terminals to excessive force.

Tightening torque: 0.98 N·m

Do not impose excessive external force on the G7J in the horizontal or vertical directions when inserting the G7J to the Faston receptacle or pulling the G7J out from the Faston receptacle. Do not attempt to insert or pull out more than one G7J Unit together.

Do not solder the tab terminals.

Terminal	Receptacle	Housing
#250 terminal (6.35 mm in width)	AMP170333-1 (170327-1) AMP170334-1 (170328-1) AMP170335-1 (170329-1)	AMP172076-1: natural AMP172076-4: yellow AMP172076-5: green AMP172076-6: blue

Note: Numbers in parentheses are for air feed use.

Operating Coil

Internal Connections of Coils

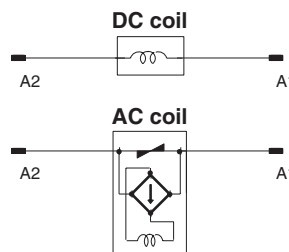

If a transistor drives the G7J, check the leakage current, and connect a bleeder resistor if necessary.

The AC coil is provided with a built-in full-wave rectifier. If a triac, such as an SSR, drives the G7J, the G7J may not release. Be sure to perform a trial operation with the G7J and the triac before applying them to actual use.

ALL DIMENSIONS SHOWN ARE IN MILLIMETERS.

To convert millimeters into inches, multiply by 0.03937. To convert grams into ounces, multiply by 0.03527.

Cat. No. J088-E1-03

In the interest of product improvement, specifications are subject to change without notice.